

# AT motion

powered by Gravo Elevators

Our strategy is  
not to compete  
to be the best  
but about being  
unique in our  
business

More Than  
**2450**  
Elevators  
Installed





## Welcome!

Gravo has believed that there is only one mantra for success Quality. Gravo Elevators is into manufacturing of Elevators with total integration adhering to all the quality and safety norms. Various equipments like Gear boxes, duty motors, Driving sheaves, crams (made of wood, M.S., S.S., Gold plated, etc.) Over-speed governors, Door Locks, Microprocessor controllers, Guide rails and many more manufactured using the most modern methods of production under one roof in a fully equipped plant located at Ahmedabad, India.

## Why us?

- All projects are properly planned in detail with CAD / CAM designs.
- All the technicians are well trained.
- End Customer satisfaction is our Policy.
- Determined to provide quality products with quality services.
- Continuous effort by our R & D department to keep in pace with the changing global standards of safety & style.
- 100% inspection & testing of all components.
- World class engineering, international styling, complete safety & smooth ride with user friendly control.
- Maintains safety standards.



### Our Vision

- To provide lavish feeling to everyone by offering customized moving solutions



### Our Value

- Commitment
- Best quality & Service
- Trust
- Fearless & risk taker
- Responsibility



### Our Mission

- Empowering Individuals with choice in purposeful living

## **MACHINE** Room System

GRAVO Provides “Best In Class” ride quality on every equipment that we install. Machine room passenger elevator is one of most popular product in both private and public sectors.

Our MR Passenger elevator applies small bulk, is light weight and has a highly efficient and permanent magnet synchronous (PMSM) gearless traction machine placed in a very compact space. As a result, it saves up to 40% energy when compared to traditional traction machines.

The latest global invention permanent magnet synchronous gearless traction machine effectively reduces energy consumption and saves up to 40% energy compared to traditional geared machines, reducing building maintenance costs. Environmentally, it is free from oil pollution and has a very low noise.

As gearless PMSM machines are designed to cater to a new age in infrastructure, GRAVO compact and sturdy design ensures superior space management in the machine room along with easy maintenance and handling of equipment.

Easy accessibility to the equipment in high rises and multi-storey buildings is essential today and this concept enhances that. Considering multiple elevators in one building or high speed elevators, proper ventilation and accessibility of machine rooms in multi-storey buildings go a long way in ease of maintenance and engineer safety.

**Controlling  
Every Move  
Safely, Precisely and  
Efficiently**

# MACHINE

Roomless System



## ECO Friendly

The Machine room-less elevator is a great leap in technology that hugely enhances the mobility experience. It is the result of years of research and technological advancement that allows a significant reduction in size of the electronic motors used with the traction machine.

MRL elevator not only look fabulous in new constructions and major renovation projects but when compared to standard elevator equipment. It saves substantial construction space and building expense. Its features include excellent reliability and durability, is oil free and operates silently.

### Energy Saving



MRL elevator is backed by new age technology of permanent magnet synchronous gearless traction machine that reduces energy consumption and saves up to 40% energy compared to traditional machines.

### Compact Design



Our light-weight MRL elevators are smartly designed to meet the expectation and flexibility of contemporary architecture.

### Construction Cost Saving



With no requirement of machine room, the elevator control system can be fixed at the last stopping or within the elevator shaft without taking additional space. This reduces construction costs and increases space utilization.

### Flexible to building design



MRL elevators open an entire horizon of trendy, flexible building designs. Without a machine room, architects and designers can play around with space using options.

**MANUAL**   
DOORS ELEVATOR

Manual Passenger Elevators for economically suited all type of Residential Commercial Buildings depending upon the shaft size with speed / amenities up to choice of owners.

ECONOMIC



Capacity **15 to 20** Passenger

• Ceiling •



Application :



Apartment



Industrial Building



Offices

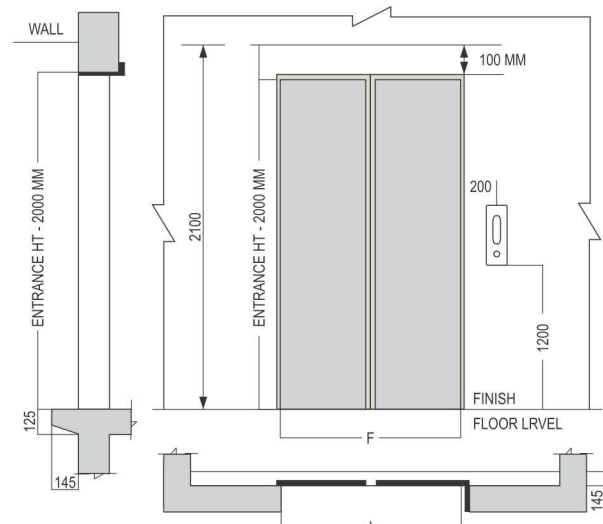

Details at Door Opening



# ECONOMIC

## Manual Door

- The passenger elevators detailed here are designed to handle promptly and efficiently the transportation requirements of any type of building-which means any traffic condition.
- They are renowned for fine quality and robust performance.
- Delivers maximum lifting power with a minimum of effort.
- A superior combination of flexibility and performance.
- It gives benefits of jerk less traveling, economically low power consumption and excellent design.
- Features : Cent percent safety, Easy to use an maintain.



The materials used in every Total Elevators lift car is of the highest quality and durability.



Manual Collapsible Door



Imperforated Door



M.S. Powder Coated Frame Full Glass Swing Door



Manual Telescopic Door



Manual Swing Door

**AUTOMATIC**   
DOORS ELEVATOR

Door systems are crucial to elevator performance therefore we offer doors and architraves to suit a variety of elevator needs and applications.

We use 3VF drive technology to provide linear acceleration and deceleration, improved elevator flight times, self adjusting obstruction control and automatic door protection systems to achieve safe entry and exit.

# STANDARD



Capacity 04 to 20 Passenger

Total elevators door systems focus on three main areas, safety, reliability and speed.

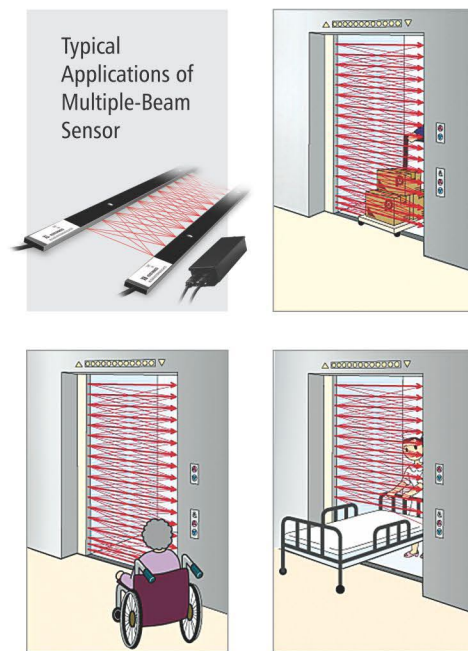

Top Advance Door Operator System

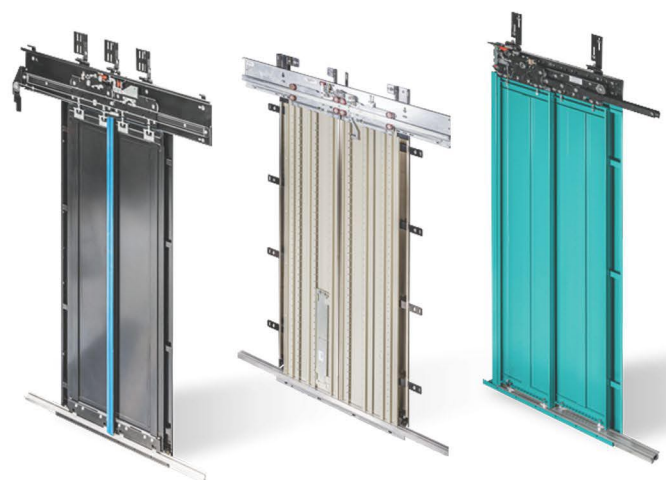
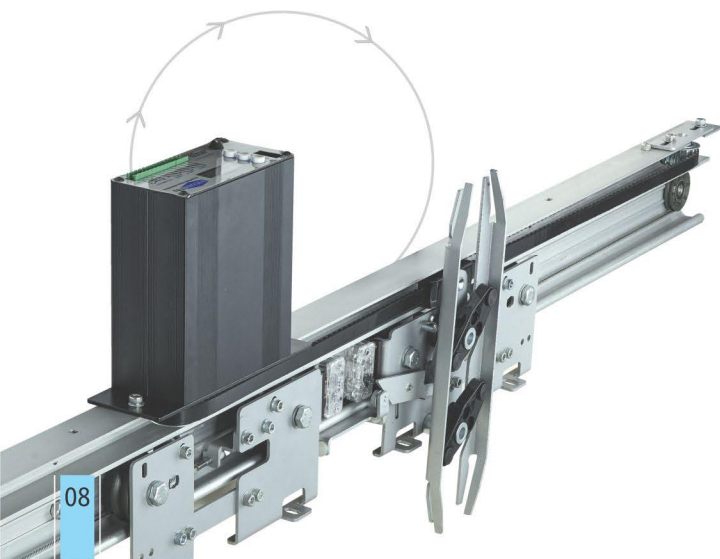



# STANDARD

Durability & Style  
in all Imaginable  
Variations.



## Smooth & Comfortable



S.S. Center Opening Autodoor



S.S. Telescopic Door



Glass Door (Big Vision)



Small Vision Autodoor



Glass Door (Full Vision)



Center Opening Autodoor  
(Four Panel)



Capacity **06 to 20** Passenger

We design panoramic cabins for those who want to enjoy the view from above.

Square, semi-circular or completely circular, our panoramic cabins are perfectly covering the most demanding design requirements.

Due to the enormous flexibility in choosing forms and materials, each panoramic cabin is always designed and constructed in absolute harmony with the architectural style of each building.

## Enjoy the View

There is a variety of forms to meet different needs.



Full Glass Capsule



Three Side Glass With MS Powder Coated Car



Three Side Square Glass Capsule



Round Glass Cabin With Stainless Steel Hair Line Finish Car

### Application :



Hotels



Shopping Malls



Offices



Multiplexes



### Cab Exterior

Full glazing	Laminated safety glass
Cab exterior panelling	Stainless steel, satin finish, concealed fixing
Ceiling rails	Stainless steel, satin finish
Platform	Aluminum bulb plate all-over
Crossarms and traction angles	lacquered
Door drive	lacquered

## HOSPITAL ELEVATOR



Capacity 15 to 26 Passenger

Hospital Elevator provide easy transportation of patients and bulky medical equipment such as gurney, stretchers and wheel chairs.

These lifts feature sophisticated looks and operated smoothly.

Hospital Elevators are available in a wide variety, capable of carrying between 15 to 26 passengers at a time.

These elevators usually center-opening, telescopic power-operated doors and easy to use for people.



Intellectual Control



Noise Reducing



Smooth and Comfortable

Features :

- Speed options from 0.35 m / sec to 1.5 m / sec.
- Capacity options from 15 to 26 passengers.
- Car and door finish options - powder coated / stainless steel.
- PVC / Chequered flooring.
- Various types of door options such as collapsible / imperforated / Telescopic / automatic centre opening doors.

## Safe & Sound...less!

- Smooth and secure
- Electromagnetic compebility (Optional)
- Emergency landing device (Optional)

Special function for the handicapped fulfill equal carrying in a harmonious space





A freight elevator is used to carry goods only though some do both to allow operators and those loading goods along for the ride.

Freight elevators are typically larger and capable of carrying heavier loads than a passenger elevator, generally from 2,300 to 4,500 kg. Freight elevators have manually operated doors and often boast rugged interior finishes to prevent damage while loading and unloading. Although hydraulic freight elevators exist, electric elevators are more energy-efficient for the work of freight lifting.



Capacity **500 to 3000 Kg.** Load

Features :

- ▶ Outstanding power and performance.
- ▶ Easy loading and unloading.
- ▶ Extra wide doors.
- ▶ Easy maintenance with low operating and maintenance cost.

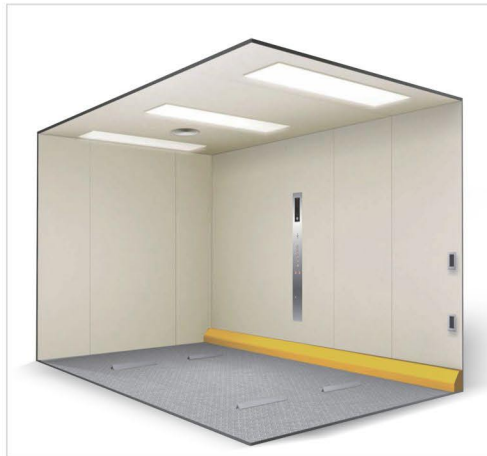

Heavy Duty Powder Coated Cabin

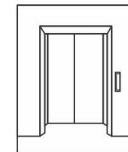

Two Panel Sliding Panel



Center Opening & Double Folded

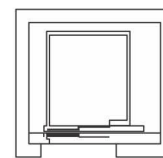

Single Way Door

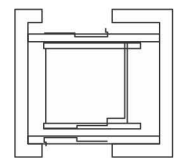

Double Way Door

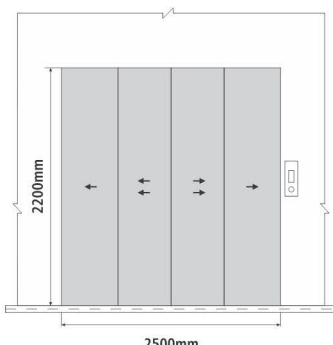

Centre Opening Automatic Landing Door

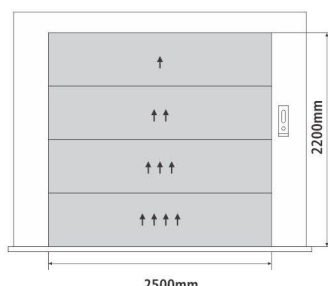

Vertical Opening Automatic Landing Door

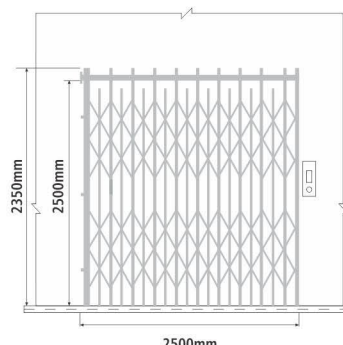

Collapsible Landing Door





Car elevators help to alleviate the problems of finding sufficient parking space in busy areas, and save on costly land in commercial space.

These lifts smoothly transport vehicles to the tops of building, or to basements and showrooms.

They are carefully engineered for independent access of vehicles in private homes or multi-family residences where space is valuable.



Capacity **1500 to 5000 Kg.** Load

## The Most Reliable Parking Assistants

### Features :

- Auto / Manual door opening Option.
- Two side opening option.
- These are safe and reliable.
- Heavy duty traction machine.



S.S. Checkered Plate

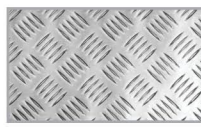

Aluminum Checkered Plate

### Characteristics of the System :

- Saves Land area and take full use of the current space to raise the number of parking cars.
- The structure is simple, united and easy for operation.
- Suitable for Car Models - Sedan for all levels & SUV for only ground level.
- Adapted Places: Apartments, yards & lower height of basements, IT parks, Hotels. It can be used both indoor & outdoor.

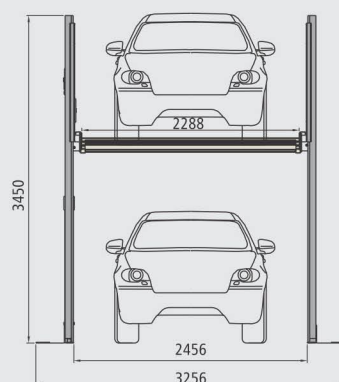
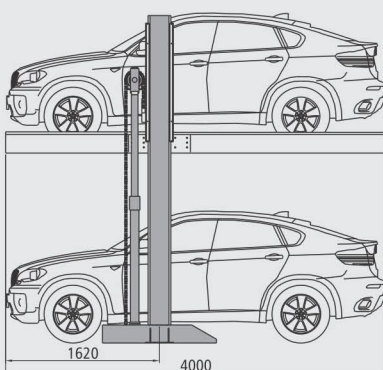

Requirements Height Sedan : 3800mm SUV : 4200mm Width : 2700mm

## CAR STACKER PARKING

Two Car Parking System





Capacity **06 to 13** Passenger

### Machine Roomless Elevator

Machine Room-Less (MRL) lifts are traction elevators that feature a compact motor drive mounted on the car itself. They don't require to build a separate elevator machine room.

MRL lifts allow you architectural flexibility, but they also provide fast, powerful and energy-efficient transportation. Though traction lifts were originally limited to high-rises, the innovative MRL design has allowed engineers to adapt traction elevators for low-rise buildings and multi-story homes.

### Advantages of MRL elevators:

- Permanent Magnet Gearless Machine for smooth and quiet motion.
- 1 m/s to 1.6m/s speed range (180 starts per hour).
- 10 to 16 passenger load range (680 - 1088kg).
- Smooth ride, due to the first-class roller shoe suspension.
- Versatile landing and car door configurations.
- Earthquake-friendly jugged guiding.
- Small control cabinet on the upper level.
- Totally integrated system for greater reliability.
- Time and money-saving benefits: long lifespan, low operating cost, easy installation and service.
- Cost-efficient elevator application, No machine room.



Low noise



Green Environmental Protection



High efficiency and energy saving

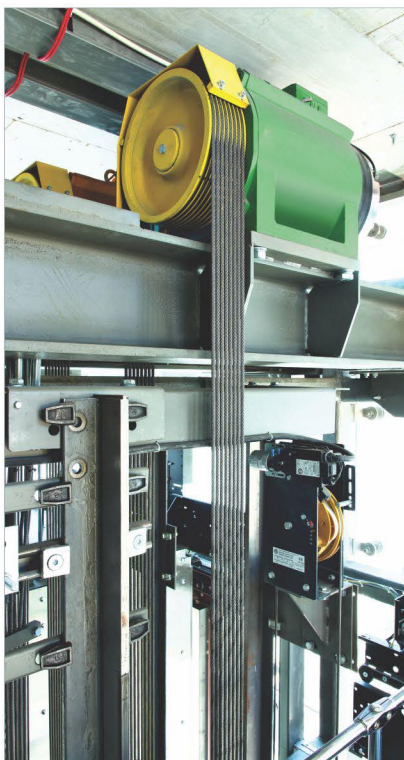

It saves 25% of total elevator equipment area.

It reduces 40% of space occupation

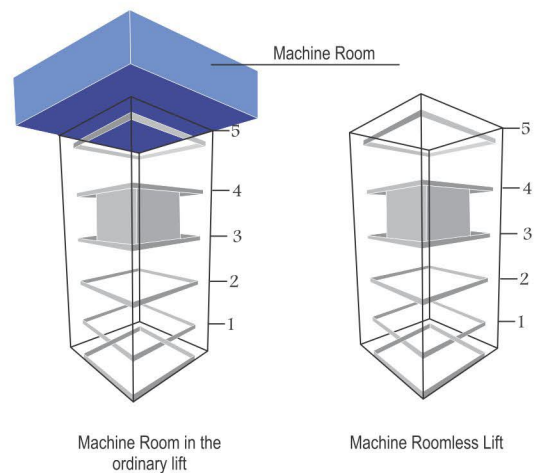



Our Company is enlisted as the reputed manufacture, service provider and supplier of Home Elevators.

Quality stands on paramount importance to us and we make no compromises in the same. Our ultra-modern home elevators compliment your home architecture. We customize our design to suit the interiors and the tested of our clients. The range is installed in multi storey houses, penthouses, bungalow and villas.



Capacity **03 to 06** Passenger

## Change Your Lifestyle with Best Home Lift

### • Landing Operating Panel •



Touch Screen with LCD Surface Mounted design with Plexiglass Panel and Zinc Alloy Out Frame

### Car Operating Panel



High Car Ceiling Height : 2100mm  
Electric Fan (Option)

LED Down Light Type (CE-EDB-C30)

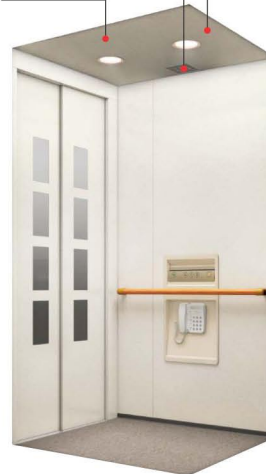

LED Rectangle Cover Light type (CE-EDB-A30)

High Entrance Height 2000mm



Entrance

- Doors / Frame : Coated steel plate
- Windows : Gray smoked plastics



Mini Gearless Machine

**40%** Energy Saving

### Main feature and benefits :

- Runs with single phase power supply.
- Required very compact overhead space and pit area.
- Saves up 40% energy compared to hydraulic elevator.
- Noiseless and vibration free.
- Easy to install and maintain.



**HYDRAULIC**  
ELEVATOR  
For Low Rise



Capacity **03 to 24** Passenger

The products are of the compact structure, low fault rate, easy for the Daily maintenance.

**40%** ENERGY SAVING

## Green Solutions For Better Tomorrow

Compared with traction lift, hydraulic has the following obvious advantages :

Flexible setting of the machine room position top machine room is not needed.

A machine room can be flexibly set within 0.5 meters rangers near the shaft which more comply with the individual design requirements of the constructions.

Wide loading range, strong adaptability, large car and tonnage design, maximum carrying ability reaches to 2 tons.

Saving space and energy consumption, reducing the cost counterweight device is not needed, which increases the utilization rate of the hoist way and greatly saves the construction space and cost.

### Advantages & Benefits



Machine Room Not Required.



No Maintenance.



Electric Power Not Required in Down Direction.



Easy & Fast Installation.

Direct Central Acting

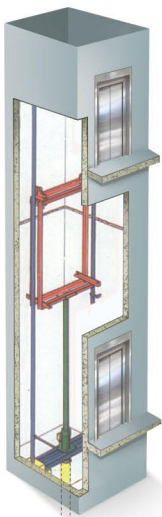

Indirect Side Acting 2:1

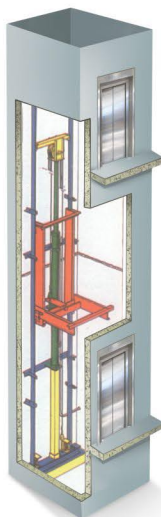

Direct Side Acting

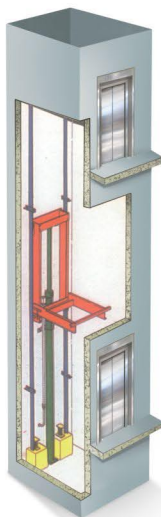

### Specifications MRL

Minimum shaft depth	400mm (constructionally)
Minimum last floor height	270mm (constructionally)
Minimum DBG	620mm
Speed	Up to 0.9m/s
Maximum travel	25m (Suspension 2:1)



**Solar Elevator**

SAVE MONEY

**Benefit of a glance**

- Availability Continuous operation even in the event of a power cut.
- Reliability. Solar elevator based on the successful and reliable GRAVO.
- Clean energy balance. Optimized energy supply with solar energy as the main source.
- Energy regeneration. Energy is recuperated to charge the Energy Storage Device (ESD).
- Easy integration.
- Single-phase plug-in solution to the building.



The elevator can be operated with solar energy or a combination of both depending on the configuration and available sunlight even a fully solar operation is feasible.

Solar panels are placed on the rooftop of the building to create the power for the elevator. They panels are sized based on the building's anticipated traffic, and how much power would be needed during extended periods of reduced sunlight. The energy that is captured by the solar panels can be used immediately & stored in batteries.

It is an another option of advanced level ARD , we can run our lift in high speed, that is why we can say it's a Stop-less Rescue Device.

The solar elevator also offers unique advantages in markets that experience frequent power outages, a common headache in developing world. Taping into the stored solar energy helps. Ensure continuing of operation & helps minimize the risk of entrapments.



**100 %  
Performance  
Zero net energy use**

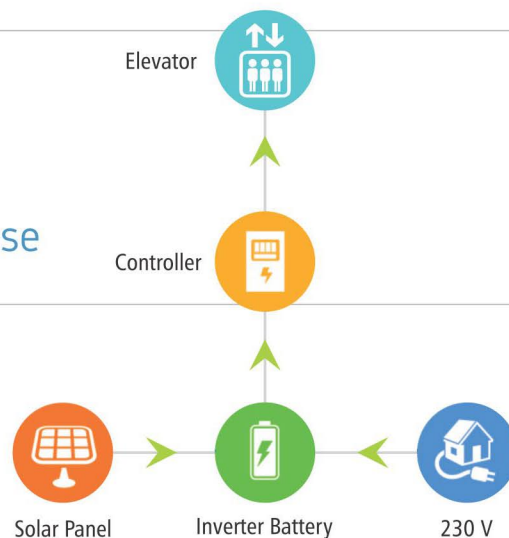

# Create Exclusive Elevator Cabin Series



## ECONOMIC

### GRAVO - 01

Side Walls	Tow Color M.S. Powder Painted
Back Wall	Tow Color M.S. Powder Painted
Celling	Acrylic + LED Light
Floor	Rubber Sheet
Handrail	Chrome Handrail
Ventilation	Blower Fan

## ECONOMIC GRAVO - 02

Car Wall	M.S. Green Coating
Car Door	M.S. Powder Coating
Handrail	Titanium gold wooden handrail
Floor	Matt Finish Wonder
Back Wall	Glass Mirror Finish

### Etching Designs



AG 117



AG 102



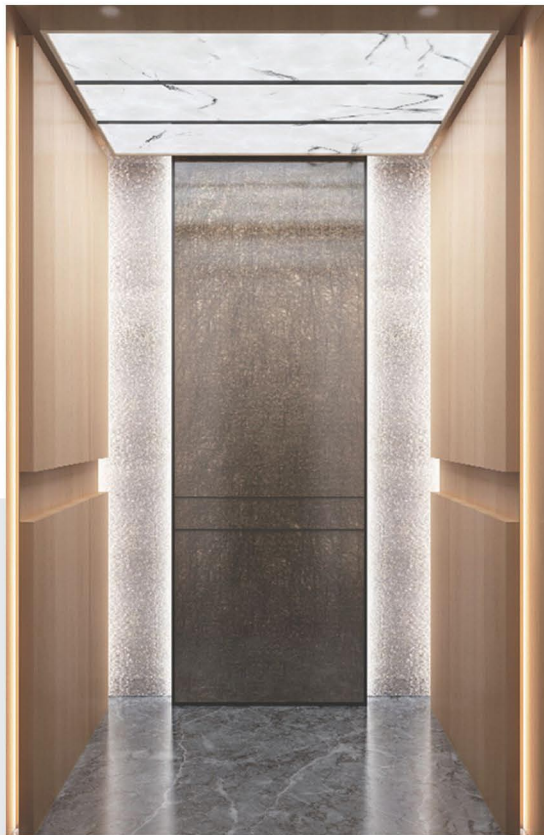

**CLASSIC**

GRAVO - 03

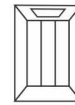

<b>Car ceiling</b>	Mirror stainless steel, luminescent micalex. LED.
<b>Car wall</b>	Hairline stainless steel, titanium mirror stainless steel.
<b>Handrail</b>	Home Elevators-HD-V002
<b>Floor</b>	Standard PVC (optional marble).

**CLASSIC**

GRAVO - 04



<b>Lighting</b>	Full lighting
<b>Ceiling</b>	Milky white resin panels
<b>Walls</b>	Colored (bronze)
<b>Transom panel</b>	Colored (bronze)
<b>Floor</b>	Matt Finish Wonder

Etching Designs

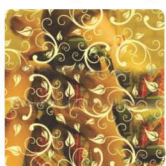

AG 103



AG 129



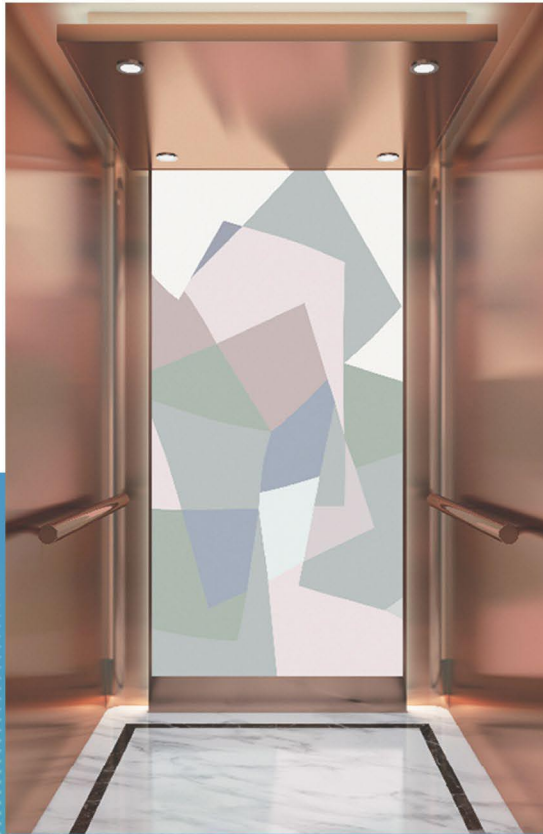

## STANDARD

### GRAVO - 05

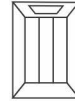

**Car ceiling** Four side LED light, imitation bronze stainless steel LED lamp belt.

**Car wall** On both sides of the imitation bronze, stainless steel back wall decoration frame LED lights belt

**Floor** Standard PVC (optional marble).

## STANDARD

### GRAVO - 06



**Ceiling** Mirror stainless steel, Acrylic transparent plate

**Car wall** Mirror stainless steel + mirror etching stainless steel

**Floor** Standard PVC (Optional Marble)

**Handrail** Stainless steel flat handrail.

#### Etching Designs



AG 112



AG 108





**ELEGANCE**

GRAVO - 07

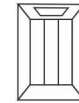

<b>Ceiling</b>	Titanium gold mirror frame, Acrylic light decoration, Down lamp
<b>Car Wall</b>	Titanium gold stainless steel, Titanium gold stainless steel mirror
<b>Handrail</b>	Titanium gold mono-tube round handrail
<b>Floor</b>	Standard PVC (optional marble).

**ELEGANCE**

GRAVO - 08



<b>Ceiling</b>	Titanium gold mirror, Titanium gold etched mirror, European style dome lamp
<b>Car Wall</b>	Etched titanium gold mirror, Marble, Titanium gold mirror
<b>Handrail</b>	None
<b>Floor</b>	Standard PVC (optional marble).

Etching Designs

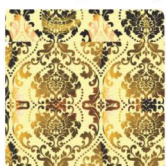

AG 155



AG 179



# Hospitality

For  
**HOSPITAL**



GRAVO - 09

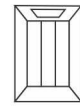

<b>Ceiling</b>	Stainless Steel Finish + LED Light
<b>Car wall</b>	Stainless Steel Finish
<b>Floor</b>	Granite Sheet
<b>Handrail</b>	Tow S.S. Finish Round Handrail
<b>Ventilation</b>	Blower Fan

For  
**HOSPITAL**

GRAVO - 10



<b>Ceiling</b>	M.S. Painted Finish + LED Light
<b>Car wall</b>	M.S. Painted Finish
<b>Floor</b>	Granite Sheet
<b>Handrail</b>	Tow S.S. Finish Round Handrail
<b>Ventilation</b>	Blower Fan



# Cargo



For **GOODS** Heavy Material

## GRAVO - 11

Car Ceiling	Steel plate with spring plastics
Car wall	Steel plate with spring plastics
Car door	Steel plate with spring plastics
COP	Hairline Stainless Steel
Car Floor	Steel plate with decorative design
Door Opening	Side Opening

Flooring  
Option

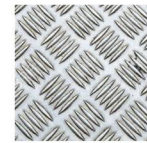

Metal Floor Texture



Checked Steel Plate

For **GOODS**  
**GRAVO - 12** 

Car Ceiling	M.S. powder coted
Car wall	M.S. powder coted
Car door	S.S. Four Fold Center Opening
COP	Hairline Stainless Steel
Car Floor	Steel plate checked design
Door Opening	S.S. Four Fold Center Opening

Flooring

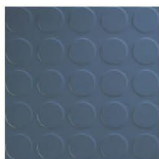

Rubber Flooring  
(Blue)



Rubber Flooring  
(Ivory)

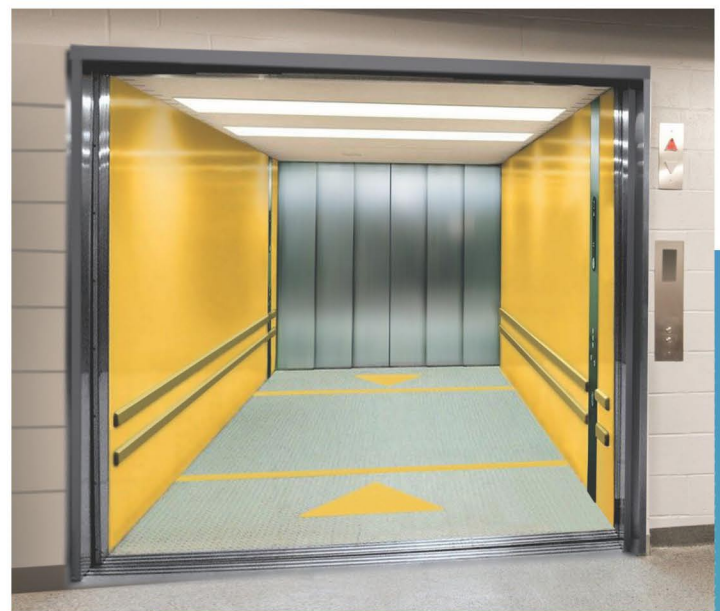

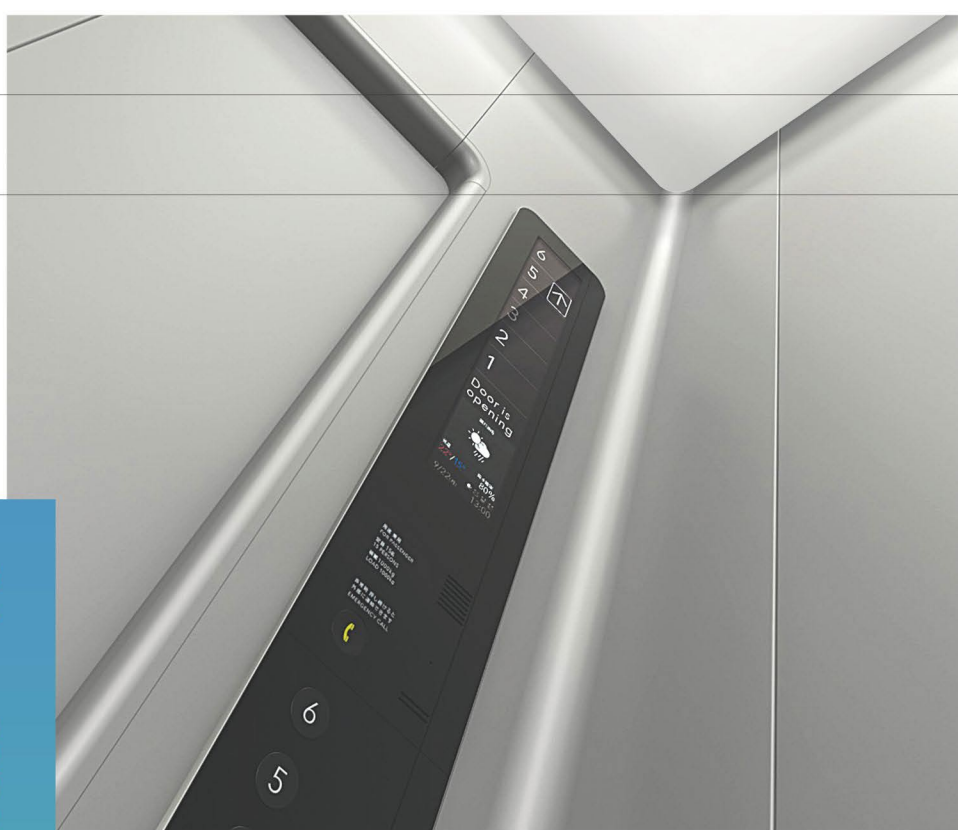

Our control panels, for both car and landing, use technologically advanced products of modern design and functionality.

The integration of buttons, symbols, communication, alarms, security and key functions ensures the passengers is in full control. Total Elevators range of push button panels, both in the car and on the landing, are of the highest quality and can be mounted to suit any architectural requirements.

Elegant design.  
Easy to operate.  
An invitation to  
passenger control.



TFT Color Display



Monochrome Display

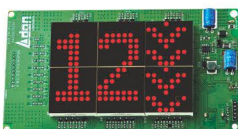

Dot Matrix Display



KCG 351



KXG351



PPG-01C



PPG-01L



HCS-CSM  
301-CB



HCS-LSM  
301-CB



Glass COP



Glass LOP



BCK 141



BXX 141



KCG 311



KXG 311



**MACHINE**

Using high quality gear drive machines and V3F Drives, these lift performance is of the highest standard



**Geared Traction Machine**



**Gearless Traction Machine**



Belt Drive Machine

**CONTROLLER**

**High Precision Positioning Control System**



MRL Panel



Microprocessor with Integrated Controller



Standard Panel



Automatic Rescue Device

**V3F Drive**





## MANUAL DOOR ELEVATOR

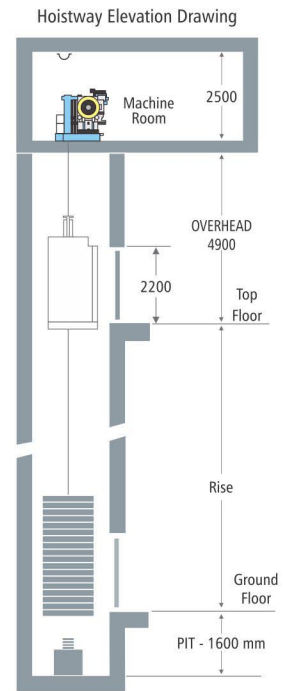
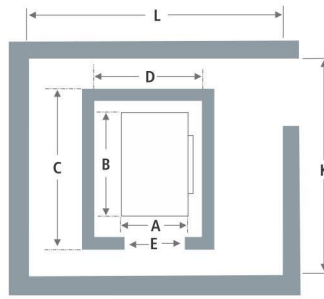

Load		Platform Edges		Lift-Well In Side Finished		Entrance Width		Door Type	Machine Room		Speed Mps	Pit Depth	Over Head
Persons	KG	A	B	C	D	E	K		L				
5	340	950	1300	1350	1650	760	Collapsible	600+C+600	300+D+1500	Up to 0.68	1600	4900	
5	340	1300	1000	1700	1300	760		300+C+300	600+D+1500				
6	408	1200	1200	1600	1500	800	Imperforate	300+C+300	600+D+1500				
8	544	1500	1200	1900	1500	800		600+C+600	300+D+1500				
13	884	1900	1500	2400	1850	900							

- All Dimension are in mm. • This is General Data, it may be changed without notice. For more details contact us.
- All hoist way walls should be minimum 230 mm brick or 150 mm R. C. C.

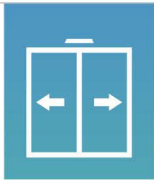

## AUTOMATIC DOOR ELEVATOR

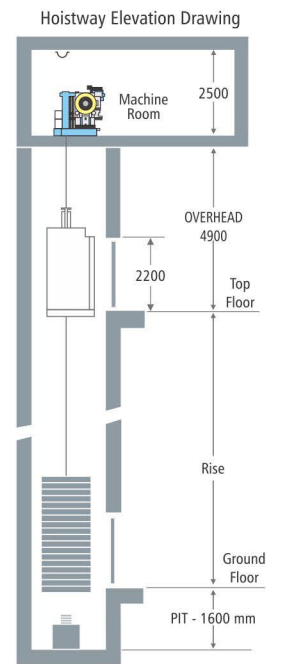
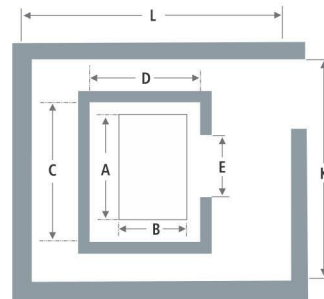

Load		Platform Edges		Lift-Well In Side Finished		Entrance Width		Door Type	Machine Room		Speed Mps	Pit Depth	Over Head
Persons	Kg	A	B	C	D	E	K		L				
6	408	1200	1300	1700	1800	700	Auto Center Opening	300+C+300	600+D+1500	UPTO 1.5	1600	4900	
8	544	1500	1330	2000	1800	800		300+C+300	600+D+1500				
10	680	1650	1450	2150	2000	800		600+C+600	600+D+1500				
13	884	1900	1500	2400	2000	900		600+C+600	600+D+1500				

- All Dimension are in mm. • This is General Data, it may be changed without notice. For more details contact us.
- All hoist way walls should be minimum 230 mm brick or 150 mm R. C. C.



## CAPSULE ELEVATOR

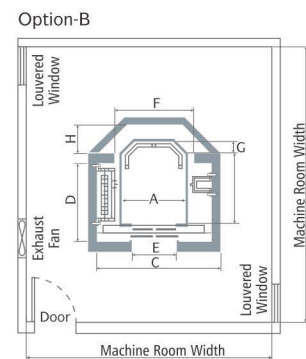
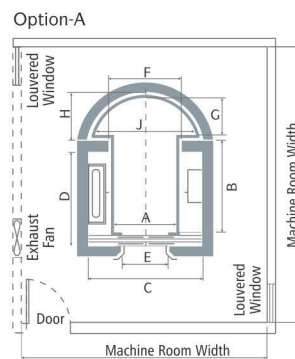

### Options - A

Load	Car Inside				Left Well				Entrance	
Person	Kgs.	A	B	J	G	C	D	F	H	E
10	680	1100	1300	1400	650	2200	1325	1330	1100	800
13	884	1200	1400	1550	700	2400	1425	1430	1100	900
16	1088	1300	1500	1700	750	2800	1530	1530	1200	1000

### Options - B

Load	Car Inside			Left Well				Entrance	
Person	Kgs.	A	B	G	C	D	F	H	E
10	680	1250	1300	250	2200	1450	1480	580	800
13	884	1400	1400	300	2400	1550	1630	650	900
16	1088	1550	1500	350	2800	1780	1650	790	1000



## HOSPITAL ELEVATOR

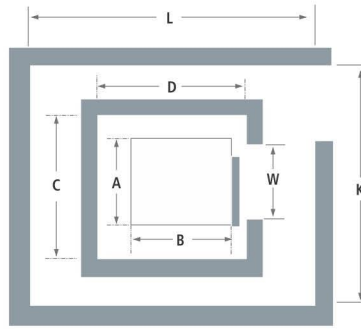

### Space Requirements for Manual Door Operation Stretcher Elevators

Load		Platform Edges		Lift-Well In Side Finished		Entrance Width	Door Type	Machine Room		Speed Mps	Pit Depth	Over Head
Person	Kg	A	B	C	D	E		K	L			
8 To 16	544 To 1088	1200	2300	1900	2400	1600	Collapsible	600 + C + 600	600 + D + 1800	0.3 To 0.5	1600	5100

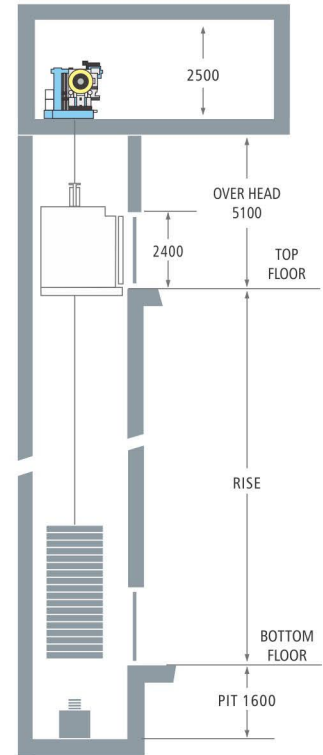

### Automatic Centre Opening Door

### Automatic Telescopic Door

Person	Capacity	Shaft W	Shaft D	Car W	Car D	Shaft W	Shaft D	Car W	Car D	Entrance
	KG.	A	B	C	D	A	B	C	D	E
15	1020	1900	3000	1000	2400	1700	3000	1000	2400	800
20	1360	2300	3000	1300	2400	1950	3000	1300	2400	900
26	1768	2600	3000	1600	2400	2100	3000	1600	2400	1000

- All Dimension are in mm. • This is General Data, it may be changed without notice. For more details contact us.
- All hoist way walls should be minimum 230 mm brick or 150 mm R. C. C.



## GOODS ELEVATOR

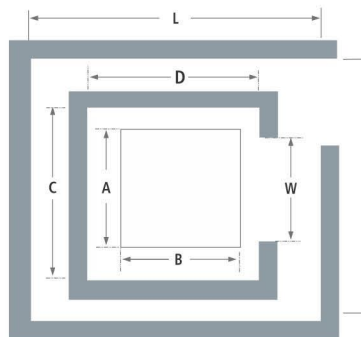

### Space Requirements For Goods Elevators

Load	Car-Inside		Lift-Well		Entrance Width	Machine Room		Load Kg	Speed Mps	Pit Depth	Over Head
KG	A	B	C	D	W	K	L				
500	1500	1200	1900	1600	1500	2500	4100	500 - 3000	0.25 To 1.0	1600	5100
1000	1500	1800	2300	2000	1800	2500	4700				
1500	1700	2000	2600	2300	2100	2600	4900				
2000	1700	2500	2600	2900	2400	2600	5400				
2500	2000	2500	2900	2900	2700	2900	5400				
3000	2000	3000	2900	3400	2700	2900	5900				

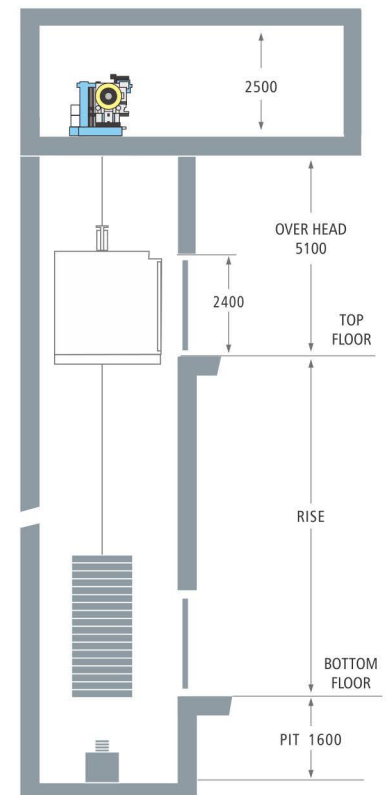

- All Dimension are in mm. • This is General Data, it may be changed without notice. For more details contact us.
- All hoist way walls should be minimum 230 mm brick or 150 mm R. C. C.



**CAR ELEVATOR**

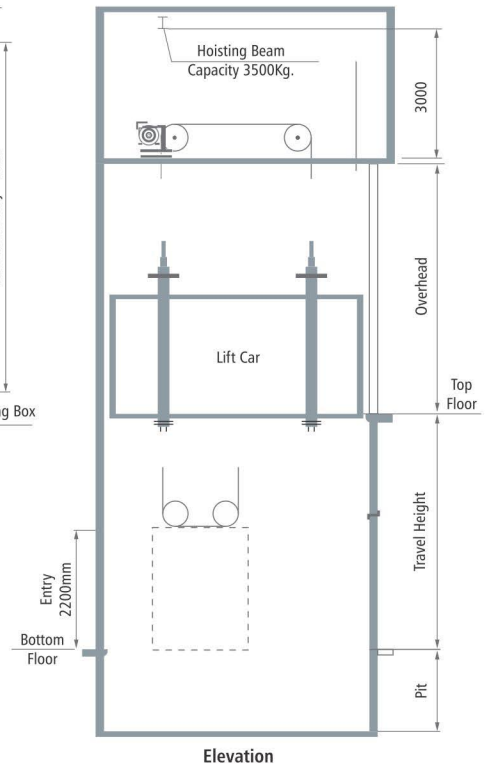
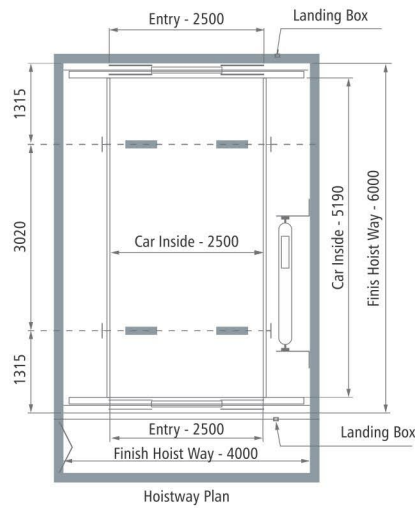

Description	Vertical Transportation for Cars / LMVs
Segment	Industrial applications & Car Parks
Max. Travel (m)	100 (Solutions available for higher travel)
Max. Load (kg)	500 - 5000 Kg per persons (Solutions available for higher capacities)
Max. Speed (m/s)	0.5 mps (Solutions available for other speeds)
Max. Group size	Simplex



**MRL ELEVATOR**

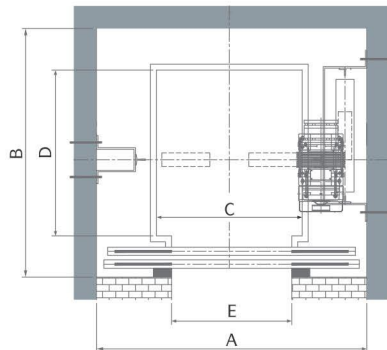
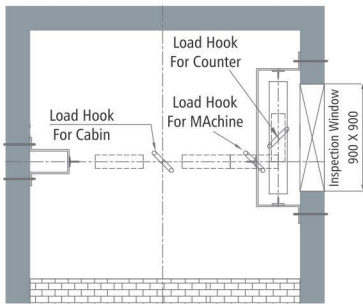

3 Nos:- Load Hook (3 Ton Capacity)  
Client Scope Refer Details  
in Inspection Window at Terrace Level

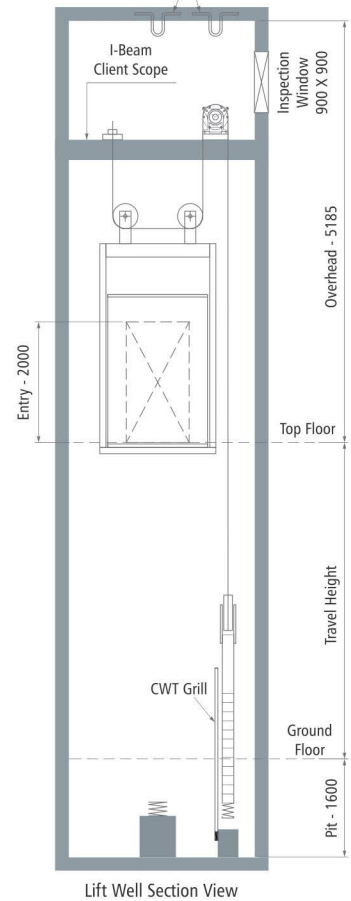

Capacity		Lift Well		Cabin Inside		Entry
Person	Kgs.	A	B	C	D	E
5	340	1600	1500	920*	1050	700
6	408	1650	1600	970*	1130	700
8	544	1850	1700	1120	1280	800
10	680	2000	1850	1270	1380	800
13	884	2100	2600	1070	2100	800/900
15	1020	2100	3000	1070	2400	800/900
20	1360	2300	3000	1320	2400	900/1000
26	1768	2450	3000	1620	2400	900/1000



## HOME ELEVATOR

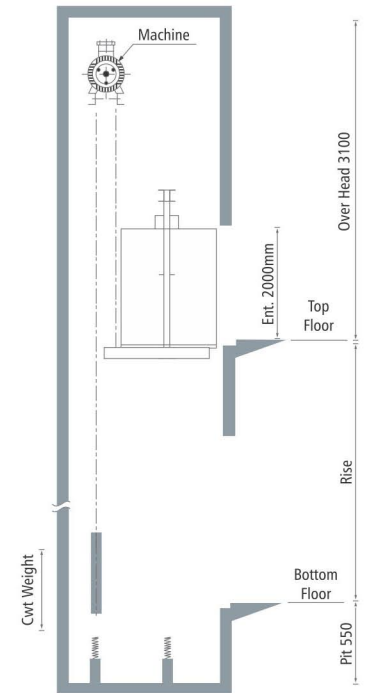
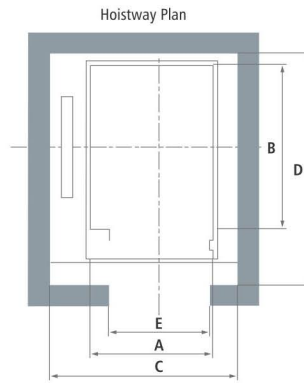

Dimensions Table

Door Operation	Load		Car Inside		Lift Well		Entrance	Speed (MPS)	Pit	Over Head
	Persons	KGS	A	B	C	D				
Manual Door	3	204	810	700	1100	1200	700	0.3	550	3100
Manual Door	4	272	800	1200	1300	1400	700	0.3	550	3100
Auto Door	3	204	810	700	1250	1250	700	0.3	550	3100
Auto Door	4	272	850	1150	1300	1600	700	0.3	550	3100

Note : This Is Our Standard Data, If other Special Requirement Please Contact us.



## HYDRAULIC ELEVATOR

It is a direct suspension with a simple or split piston.  
It is the simplest solution of suspension for any load.

Person	Capacity Kg.	Shaft - W (A)	Shaft-D (B)	Car-W (C)	Card-D (D)
3	225	1200	1200	800	900
4	300	1250	1350	850	1050
5	375	1400	1400	1000	1100
6	450	1500	1500	1100	1150
8	600	1500	1700	1100	1400
10	750	1600	1850	1200	1550
12	900	1700	1950	1300	1650
15	1125	1700	2300	1300	2000
20	1500	1800	2700	1400	2400
24	1800	1900	2800	1500	2500

PIT : 1500 mm • O.H. : 4000 mm (Pit & O.H. change the technical specification)

It is a single side direct suspension with a simple piston for regular loads and short travels of maximum 4 meters.

Person	Capacity Kg.	Shaft - W (A)	Shaft-D (B)	Car-W (C)	Card-D (D)
3	225	1500	1500	800	900
4	300	1550	1550	850	1050
5	375	1700	1700	1000	1100
6	450	1800	1800	1100	1150
8	600	1800	1800	1100	1400
10	750	1900	1900	1200	1550
12	900	2000	2000	1300	1650
15	1125	2000	2000	1300	2000
20	1600	2100	2100	1400	2400

PIT : 1200 mm • O.H. : 4000 mm

### Center Bore Type (Direct)

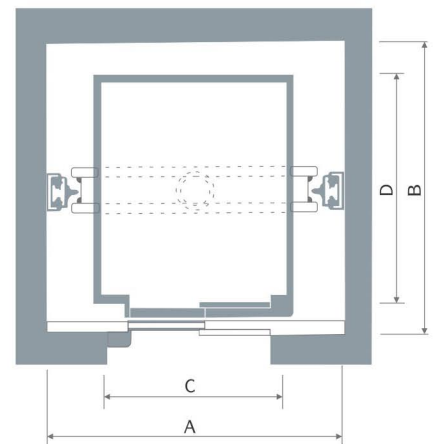

### Roping Type

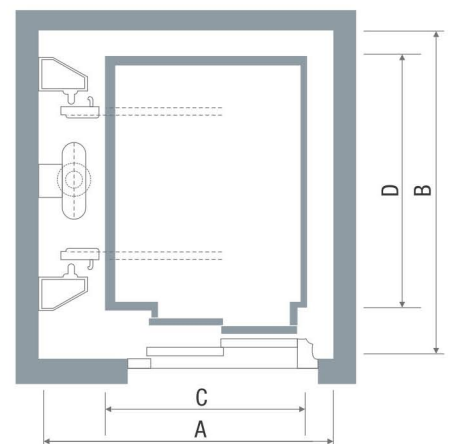

Your Safety Is  
Our Priority



## Safety Features

### AUTOMATIC RESCUE DEVICE

In the event of a power cut, the elevator will continue to operate till the nearest floor and open the doors to let passenger out safely.



### EMERGENCY LIGHT & ALARM

The emergency light is always illuminated in normal condition and switches itself to battery mode automatically in case of a power failure. Help can be obtained by pressing the alarm button which will be heard in the lobby.



### AUTOMATIC FAN OPERATION

The cabin fan automatically stops when there is no floor call registered resulting in saving power and enhancing its life.



### INFRA RED SENSOR

The full height infra red curtain/sensor with multiple crossing beams detect the smallest obstruction in the door way and stop the doors from closing.



### SAFETY IN CASE OF ROPE BREAKAGE

In the event of breakage of ropes, which is caused if the elevator speed exceeds the rated speed in the downward direction due to gravitational acceleration., the over speed governor activates the clutch mechanism thereby switching off main controls and jamming the elevator car safety on the guide rails after which the car wont move.

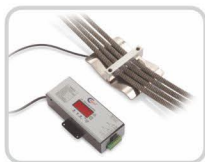

### OVERLOAD SENSOR

On overloading of the lift car, the overload sign will glow and the doors will remain open till the excess load is removed.



## QUALITY OF SERVICE

Round the clock customer call service : Any time any where

Our motto is to bring a smile on our customer's face with the finest solutions. We speak with love and compassion with our customers even during after sales services.

We believe in maintaining relationship for great partnership. Our service stands for knowledge, experience and technical support through a dedicated customer service team. Our customer service team receives call from our customers and shares the matter with our field engineers for immediate and safe service resolution.

Backed by expertise of complete elevator system solutions and proven track record of brilliant products and services, GRAVO has consistently offered highly-evolved customer support solutions and business value propositions that go above and beyond the scope of normal support solution providers.

### **Safety comes first**

Our foremost priority is to provide safety for our employees and people who are in daily use with our products. We can proudly say that GRAVO has achieved Zero Accident Credential toward installed and running equipment globally.

### **Modernization**

We aim to redefine every angle of your existing equipment.

We have a wide range of modernization solutions for your existing equipment, we redefine your old equipment through replacement of any malfunctioning parts, either from our equipment or of any other manufacturer. Our concept of modernization is designed to meet the customer's requirement of having an elevator that matches with the needs of new era.

GRAVO offers various types of modernization plans that are categorized as per customer's exact needs and capitalization.





**Zonal Office Patna :**

501, Kundan Complex,  
Colony More, Kankarbagh,  
Patna - 800020.

Phone : 0612 - 2350161.  
Mobile : + 91 94732 21515  
99736 77819  
Service : + 91 80513 33111

**Factory : Ahmedabad**

82, Abhishree Industrial Park,  
B/h. Grand Vishala, Nr. S. P. Ring Road,  
Odhav, **Ahmedabad**, Gujarat - 382415  
Phone : 95374 24777, 97099 69699

**Head Office Mumbai :**

B Wing, 20th Floor, 2003,  
HDIL Metropolis Building,  
CTS No. 866/A, 866/B,  
Nr. D N Nagar Metro Station,  
Andheri (W), **Mumbai** - 400058  
Phone. : 74110 62608

**Zonal Office Delhi :**

2nd Floor, 162 - A /9,  
Near DDA Community Centre,  
Kishangarh, Vasant Kunj,  
**New Delhi** - 110070  
Phone : + 91- 80513 33222

**Branch Office Bihar :**

1st Floor, MRF Showroom,  
Opp. Gaya Airport Gate,  
Gaya Dobhi Road, Gaya,  
**Bihar** - 823004

E-mail : [info@gravoelevators.com](mailto:info@gravoelevators.com)  
Web : [www.gravoelevators.com](http://www.gravoelevators.com)

**Branch Office :**

Kolkata, Lucknow, Noida,  
Bangalore, Chennai

**Our Centers :**

- Bhuwaneshwar
- Puri
- Burdwan
- Deoghar
- Motihari
- Kanpur
- Kharagpur
- Dhanbad
- Raipur
- Rourkela
- Asansol
- Ranchi
- Palamu
- Biharsharif
- Ghaziabad
- Cuttak
- Katihar
- Angul
- Durgapur
- Jamshdpur
- Muzaffarpur
- Gaya
- Varanasi
- Purulia
- Lucknow

We are Technically  
Associated with

